

# CARBURETTOR MANUAL



Thank you for purchasing our carburettor. Please make sure to read the following instruction prior to fitting the carburettor to your engine.

## ⚠ Note

1. This carburettor is a precision instrument. If you need to work on it make sure you do so in a clean environment.
2. If, in the course of adjusting or disassembling, the carburettor is damaged we as manufacturers do not accept responsibility.
3. The carburettor's function will be affected by factors such as air pressure, temperature, humidity and by height above sea level.
4. This carburettor requires knowledge and understanding for its setup. If you lack either of these do contact a professional for advice

Explanation of symbols:

**NOTE** Read information under this heading carefully, it is likely to help you with the understanding of essential features.

⚠ Follow procedure accurately to avoid damage of the carburettor.

**NO FIRE!** Make sure to stay clear of open flames so as to avoid unwanted fire.

**INSTALLATION CAUTION** Make sure all screws are tightened properly before starting the engine.

**READ CAREFULLY!** If any information dealt with in the manual remains unclear seek professional assistance.

## 1-1 Accessory

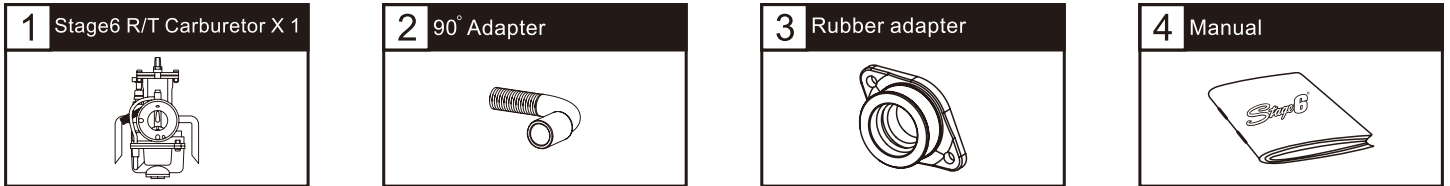

**NOTE** Please make sure the box in which your carburettor came when you bought it contains all the above items. If any of these should be missing get in touch with the dealer you bought it from.

## 1-2 Optional accessories

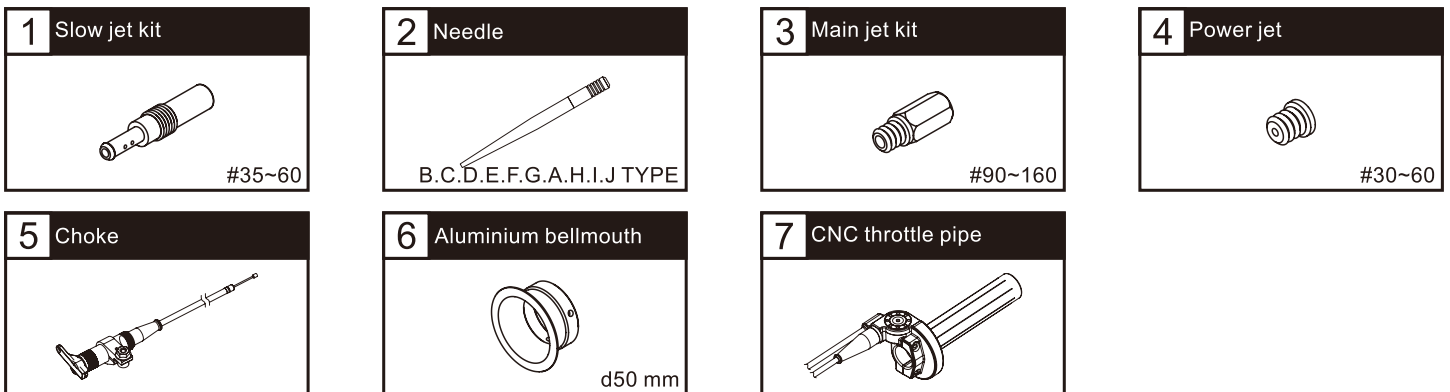

**NOTE** Some optional parts may not be sold in some markets, please check with your local distributor for it.

## 1-3 Option parts specification







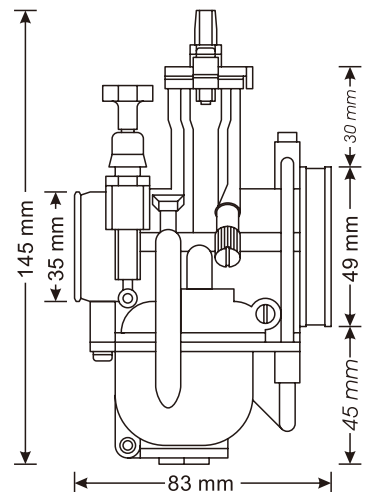



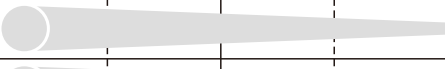

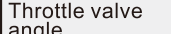

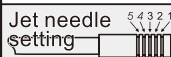
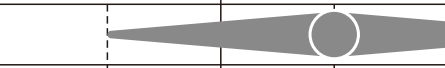
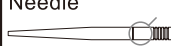

<b>1</b> Slow jet kit  28 mm	#35 #50 #38 #52 #40 #55 #42 #58 #45 #60 #48	<b>2</b> Jet needle  28 mm BCDEFGAHIJ ← Rich Standard Lean →	<b>3</b> Main jet kit  16.5 mm	#90 #110 #130 #150 #92 #112 #132 #152 #95 #115 #135 #155 #98 #118 #138 #158 #100 #120 #140 #160 #102 #122 #142 #105 #125 #145 #108 #128 #148
------------------------------------	--	--	--------------------------------------	---

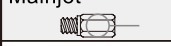
## 2 The original setting

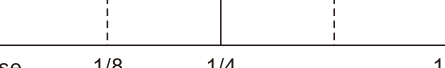
Carburetor	ø 21 / 2T	ø 24 / 2T	ø 26 / 2T	ø 28 / 2T
Air adjust screw	1 1/2	1 1/2	1 1/2	1 1/2
Slow jet	#38	#38	#38	#38
Jet needle setting	3	3	3	3
Jet needle	E	E	E	E
Main jet	#110	#120	#125	#130
Power jet	#30	#30	#30	#30



### 3-1 Basic knowledge and adjustment

Air adjustment screw  Lean Rich	Turning the adjustment screw in (clockwise) makes for a rich mixture, turning it out for a lean one.						
Idle jet 	The bigger the jet, the richer the mixture						
Throttle valve angle 	The smaller the angle of the throttle valve the richer the mixture						
Needle jet 							
Jet needle setting 	There are five options per needle, the higher the number, the richer the mixture						
Needle 	Needle types are B, C, D, E, F, G, A, H, I and J. B is the leanest, J the richest with the others in between as per the list.						
Mainjet 	The bigger the mainjet, the richer the mixture.						
Powerjet 	The bigger the powerjet, the richer the mixture.						
		Close	1/8	1/4	1/2	3/4	Open
							

- For throttle closed to one quarter throttle opening
  - Change idle jet to adjust mixture.
  - Set air adjustment screw to adjust mixture.
- From one quarter throttle opening to three quarter throttle opening
  - Adjust needle position.
  - Change needle.
- From three quarter throttle opening to full throttle
  - Change mainjet to adjust mixture.
  - Change powerjet to adjust mixture.
- Half throttle to full throttle (high airspeed in the carb)
  - Adjust mixture by changing mainjet, jet needle or jet needle setting.
  - Make sure to read the spark plug to check whether setting is correct or not (see 3.2 for details).

### 3-2 Adjusting Note

- Basic jetting of the airscrew is fully in, then 1 and a half turns out. If engine runs to rich or to lean try to adjust with airscrew, if this cannot be done within a few turns of the screw change idle jet.
- If mixture is to rich between closed and half throttle, and if this cannot be rectified with the air adjustment screw, go to a smaller idle jet.
- Running your engine to rich will result in you engine not running at its best, running it to lean will eventually damage your engine's components such as piston, cylinder and head. We therefore recommend starting on the rich side when you set up your engine and work your way down to the proper setting.
- Check and read the spark plug to learn about the mixture your engine requires.
  - Spark plug is black, or even wet: your engine runs to rich. Unburnt fuel causes soot to built up on the spark plug. Go for a leaner setting, use smaller jets.
  - Spark plug is dry and grey, or even white: Your engine runs to lean. This may lead to damage of engine components such as piston, cylinder, head, spark plug caused by overheating. Go for a richer setting, use larger jets.
  - The spark plug is brown and looks clear: Mixture is as it should be.
- When changing to a larger mainjet this will affect your engine's performance at half to full throttle. Always change one factor at a time and assess the changes this has made to the engine's performance before changing something else.
- If you run an engine to lean for a longer period it is likely to overheat and suffer damage.



### 3-3 The effect of the environment factor

Environment	Mixture situation	Adjust advise
High temperature	Rich	Lean
Low temperature	Lean	Rich
High humidity	Rich	Lean
Low humidity	Lean	Rich
High Altitude	Lean	Rich

### 4 Trouble shooting

Problem	Mixed air state	Adjusting method	Note
When idling a. Engine runs erratic. b. Rpm is not stable.	Lean	a. Turn airscrew in clockwise to make mixture richer. b. Change to a bigger idle jet. c. Change to a smaller diameter needle to make mixture richer.	a. There is a possibility that a reed petal is broken. b. There may be an air-leak in the inlet tract..
When idling a. The engine is stalled. b. Exhaust fumes are black.	Rich	a. A) Turn airscrew in to make mixture leaner. b. A) Change to a smaller idle jet. c. A) Change to a larger diameter needle to make mixture leaner.	
When riding away a. Poor acceleration	Lean	Change to a bigger mainjet.	
When riding away a. Engine runs erratic	Rich	Change to a smaller mainjet	
Between closed throttle and one quarter throttle opening a. Engine stalls and does not pick up revs.	Lean	a. Go for a thinner needle to make the mixture richer. b. Turn the airscrew in clockwise to make the mixture richer.	
Between closed throttle and one quarter throttle opening a. Acceleration is hesitant or irregular	Rich	a. Go for a bigger needle to make mixture leaner. b. Turn the airscrew out anticlockwise to make the mixture leaner. c. If these two measures do not solve the problem try a smaller idle jet	This may happen in rainy conditions in particular, pay attention to the engine temperature
Between one quarter and half throttle a. Engine brakes b. Engine bogs	Lean	Change the needle jet to a bigger one to make the mixture richer.	Please check 3.1 Basic knowledge & Adjustment
Throttle between a quarter and half open a. Acceleration is bad	Rich	Change the needle jet (siehe oben) to a smaller one to make mixture leaner.	Please check 3.1 Basic knowledge & Adjustment
Throttle is fully open a. Rpm changes erratically b. Engine Pings, Detonation c. Spark plug is dry and white	Lean	Change the mainjet to a larger one (Remember spark plug should be brown)	a. Ignition could be out, that is: too much advance b. There may also be an airleak in the inlet tract
Throttle is fully open a. Engine speed rises slowly b. Engine feels flat c. Spark plug is black	Rich	Adjust mixture by using a smaller mainjet. Keep checking spark plug until colour is correct.	Air filter could be blocked. Also check choke is not stuck.
Rapid throttle opening	Rich, lean	Check all parts involved as described above, take your time, don't rush things.	Make sure this is not caused by a broken reed petal or an air-leak in the inlet tract.